

AR8050-4



DESCRIPCIÓN

CÓDIGO	POTENCIA	VOLTAJE	VDC.OUTPUT	A.OUT
AR8050-4	1 x 5W	185-265 VAC	38-65VDC	300 mA

DIMENSIONES

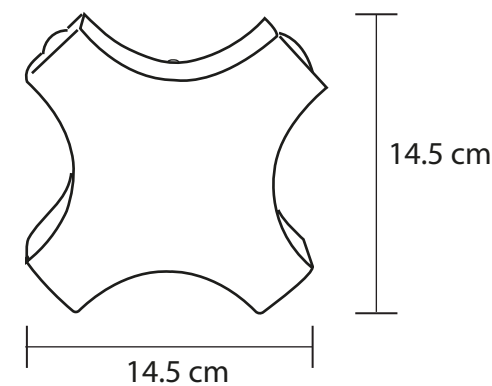

TEMPERATURA DE COLOR

Luz Calida Luz Semi-Cálida Luz Fría

